



STEEL
WINDOW
ASSOCIATION

FACT SHEET

W40 WINDOWS

W40 WINDOWS

W40 hot rolled steel profiles have been specifically designed by the SWA and for the SWA members.

They provide even greater flexibility in terms of maximum manufacturing sizes and can accommodate thicker double or triple glazed units.

Doors manufactured using W40 profiles with triple glazing can achieve a 1.5 W/m²K thermal rating. Some customers specify this system due to it being able to accommodate up to 32 mm glazing and so it can be specified with acoustic glass which may be desirable when the property is backing onto areas with persistent noise issues.

Multi locking windows and doors are available in this system



W40 WINDOWS

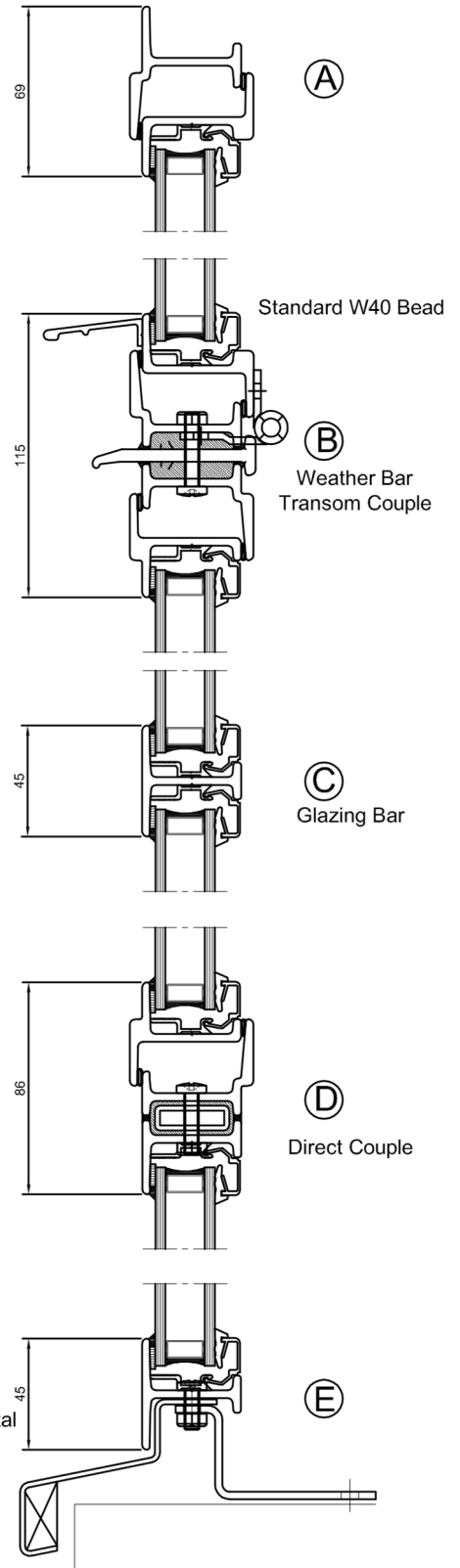
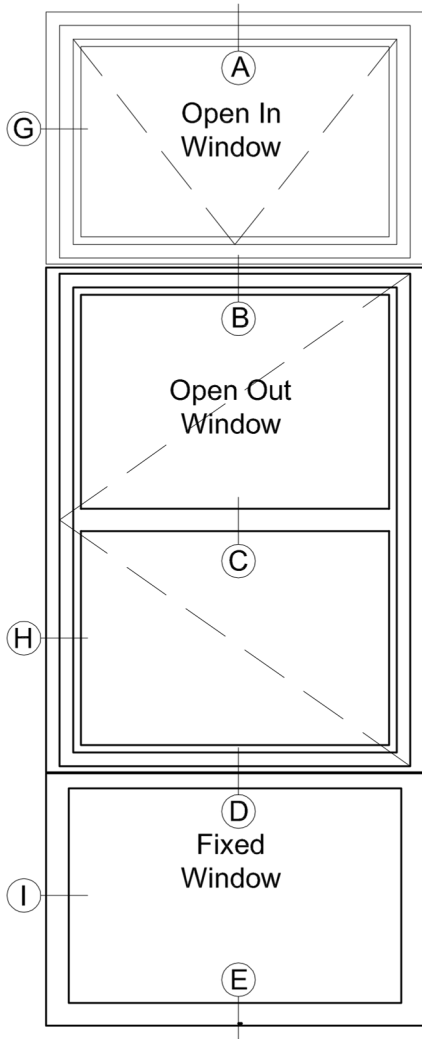

Alternate Glazing Bar

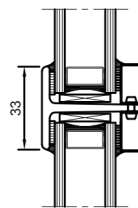

Unequal Leg Opening Inward

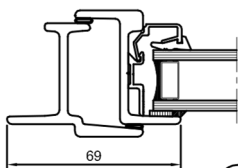

Unequal Leg Opening Outward

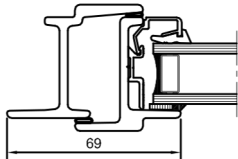

Fixed Light Section

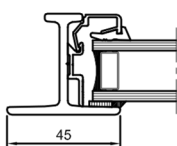

Typical Meeting Stile

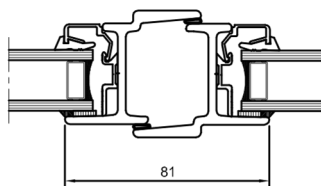

Pressed Metal Sill

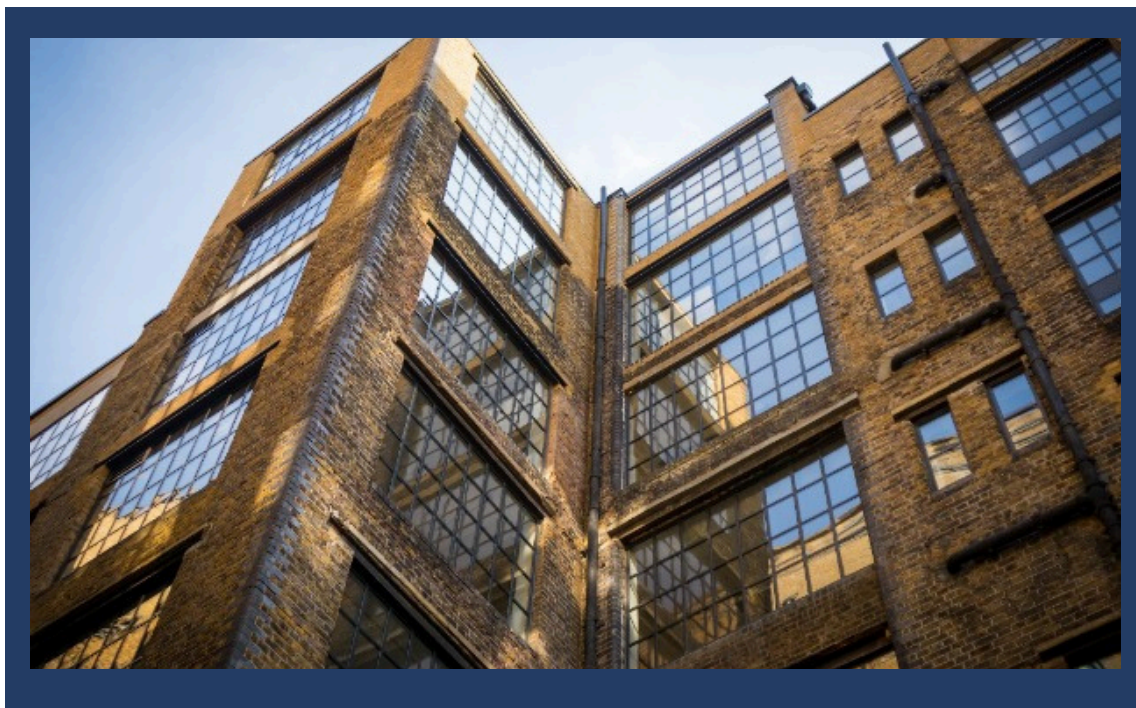

The Steel Window Association represents the great majority of UK steel window manufacturers, ranging in size from the smallest of craft-based companies that specialise in replacement and repair work, particularly on windows for Heritage buildings, through to large, multi-site companies that manufacture and install windows in literally every type of building. There is not a single steel window project of any description, anywhere in the UK, that one of the SWA members cannot handle.

All windows produced by SWA members in hot rolled steel sections to BS.6510 are protected by the hot dip galvanizing process in accordance with BS EN ISO 1461. Cold formed steel section windows are also available, and all steel section windows can be supplied with a decorative finish available in a range of colours. This process, in which polyester powder is electrostatically applied then heat fused under factory-controlled conditions to BS EN 13438, gives a high quality, attractive and durable finish with a life expectancy of at least 15 years.

The Steel Window Association supports its member companies with a wide-ranging service relating to product development, market research and promotion and the SWA helps ensure that each member operates to the highest industry standards. Every contract undertaken has the personal attention of senior management and SWA member companies operate established and flexible services in window design, manufacture, installation and repair and refurbishment.

